

रोल नं. 

--	--	--	--	--	--	--

  
Roll No.

परीक्षार्थी कोड को उत्तर-पुस्तिका के मुख-पृष्ठ पर अवश्य लिखें ।

Candidates must write the Code on the title page of the answer-book.

- कृपया जाँच कर लें कि इस प्रश्न-पत्र में मुद्रित पृष्ठ 19 हैं ।
- प्रश्न-पत्र में दाहिने हाथ की ओर दिए गए कोड नम्बर को छात्र उत्तर-पुस्तिका के मुख-पृष्ठ पर लिखें ।
- कृपया जाँच कर लें कि इस प्रश्न-पत्र में 26 प्रश्न हैं ।
- कृपया प्रश्न का उत्तर लिखना शुरू करने से पहले, प्रश्न का क्रमांक अवश्य लिखें ।
- इस प्रश्न-पत्र को पढ़ने के लिए 15 मिनट का समय दिया गया है । प्रश्न-पत्र का वितरण पूर्वाह्न में 10.15 बजे किया जाएगा । 10.15 बजे से 10.30 बजे तक छात्र केवल प्रश्न-पत्र को पढ़ेंगे और इस अवधि के दौरान वे उत्तर-पुस्तिका पर कोई उत्तर नहीं लिखेंगे ।
- Please check that this question paper contains 19 printed pages.
- Code number given on the right hand side of the question paper should be written on the title page of the answer-book by the candidate.
- Please check that this question paper contains 26 questions.
- **Please write down the Serial Number of the question before attempting it.**
- 15 minute time has been allotted to read this question paper. The question paper will be distributed at 10.15 a.m. From 10.15 a.m. to 10.30 a.m., the students will read the question paper only and will not write any answer on the answer-book during this period.

## भौतिक विज्ञान (सैद्धान्तिक)

### PHYSICS (Theory)

निर्धारित समय : 3 घण्टे

अधिकतम अंक : 70

Time allowed : 3 hours

Maximum Marks : 70

55/1/G

1

P.T.O.



## सामान्य निर्देश :

- (i) सभी प्रश्न अनिवार्य हैं। इस प्रश्न-पत्र में कुल 26 प्रश्न हैं।
- (ii) इस प्रश्न-पत्र के 5 भाग हैं : खण्ड अ, खण्ड ब, खण्ड स, खण्ड द और खण्ड य।
- (iii) खण्ड अ में 5 प्रश्न हैं, प्रत्येक का 1 अंक है। खण्ड ब में 5 प्रश्न हैं, प्रत्येक के 2 अंक हैं। खण्ड स में 12 प्रश्न हैं, प्रत्येक के 3 अंक हैं। खण्ड द में 4 अंक का एक मूल्याधारित प्रश्न है और खण्ड य में 3 प्रश्न हैं, प्रत्येक के 5 अंक हैं।
- (iv) प्रश्न-पत्र में समग्र पर कोई विकल्प नहीं है। तथापि, दो अंकों वाले एक प्रश्न में, तीन अंकों वाले एक प्रश्न में और पाँच अंकों वाले तीनों प्रश्नों में आन्तरिक चयन प्रदान किया गया है। ऐसे प्रश्नों में आपको दिए गए चयन में से केवल एक प्रश्न ही करना है।
- (v) जहाँ आवश्यक हो आप निम्नलिखित भौतिक नियतांकों के मानों का उपयोग कर सकते हैं :

$$c = 3 \times 10^8 \text{ m/s}$$

$$h = 6.63 \times 10^{-34} \text{ Js}$$

$$e = 1.6 \times 10^{-19} \text{ C}$$

$$\mu_0 = 4\pi \times 10^{-7} \text{ T m A}^{-1}$$

$$\epsilon_0 = 8.854 \times 10^{-12} \text{ C}^2 \text{ N}^{-1} \text{ m}^{-2}$$

$$\frac{1}{4\pi\epsilon_0} = 9 \times 10^9 \text{ N m}^2 \text{ C}^{-2}$$

$$m_e = 9.1 \times 10^{-31} \text{ kg}$$

$$\text{न्यूट्रॉन का द्रव्यमान} = 1.675 \times 10^{-27} \text{ kg}$$

$$\text{प्रोटॉन का द्रव्यमान} = 1.673 \times 10^{-27} \text{ kg}$$

$$\text{आवोगाद्रो संख्या} = 6.023 \times 10^{23} \text{ प्रति ग्राम मोल}$$

$$\text{बोल्ट्ज़मान नियतांक} = 1.38 \times 10^{-23} \text{ JK}^{-1}$$



### **General Instructions :**

- (i) *All questions are compulsory. There are **26** questions in all.*
- (ii) *This question paper has **five** sections : Section A, Section B, Section C, Section D and Section E.*
- (iii) *Section A contains **five** questions of **one** mark each, Section B contains **five** questions of **two** marks each, Section C contains **twelve** questions of **three** marks each, Section D contains one value based question of **four** marks and Section E contains **three** questions of **five** marks each.*
- (iv) *There is no overall choice. However, an internal choice has been provided in one question of two marks, one question of three marks and all the three questions of five marks weightage. You have to attempt only one of the choices in such questions.*
- (v) *You may use the following values of physical constants wherever necessary :*

$$c = 3 \times 10^8 \text{ m/s}$$

$$h = 6.63 \times 10^{-34} \text{ Js}$$

$$e = 1.6 \times 10^{-19} \text{ C}$$

$$\mu_0 = 4\pi \times 10^{-7} \text{ T m A}^{-1}$$

$$\epsilon_0 = 8.854 \times 10^{-12} \text{ C}^2 \text{ N}^{-1} \text{ m}^{-2}$$

$$\frac{1}{4\pi\epsilon_0} = 9 \times 10^9 \text{ N m}^2 \text{ C}^{-2}$$

$$m_e = 9.1 \times 10^{-31} \text{ kg}$$

$$\text{Mass of neutron} = 1.675 \times 10^{-27} \text{ kg}$$

$$\text{Mass of proton} = 1.673 \times 10^{-27} \text{ kg}$$

$$\text{Avogadro's number} = 6.023 \times 10^{23} \text{ per gram mole}$$

$$\text{Boltzmann constant} = 1.38 \times 10^{-23} \text{ JK}^{-1}$$



**खण्ड अ**  
**SECTION A**

1. किसी ए.सी. (a.c.) परिपथ में, तात्क्षणिक वोल्टता तथा धारा के क्रमशः मान हैं –  
 $V = 200 \sin 300 t$  वोल्ट और  $I = 8 \cos 300 t$  ऐम्पियर । क्या परिपथ की प्रकृति धारितीय है या प्रेरकीय ? कारण दीजिए ।

1

In an a.c. circuit, the instantaneous voltage and current are  $V = 200 \sin 300 t$  volt and  $I = 8 \cos 300 t$  ampere respectively. Is the nature of the circuit capacitive or inductive ? Give reason.

2. व्यापकीकृत संचार व्यवस्था के दर्शाए गए ब्लॉक आरेख में X तथा Y बॉक्सों के नाम लिखिए :

1



Name the boxes X and Y shown in the block diagram of a generalized communication system :

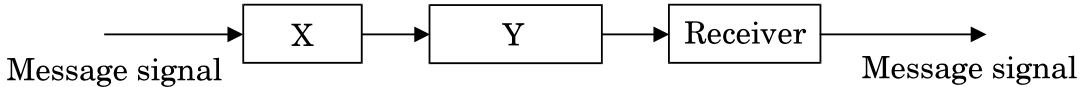

3. किसी लेंस के दोनों पृष्ठों की वक्रता त्रिज्याएँ समान (बराबर) हैं । यदि एक पृष्ठ को घिस कर समतल कर दिया जाए, तो लेंस की फोकस दूरी तथा क्षमता (पावर) किस प्रकार परिवर्तित होगी ?

1

The radii of curvature of both the surfaces of a lens are equal. If one of the surfaces is made plane by grinding, how will the focal length and power of the lens change ?

4. यदि बराबर मोटाई के कॉपर (ताँबे) तथा मैंगनिन के तारों के प्रतिरोध आपस में बराबर हैं, तो इनमें से किस पदार्थ के तार की लम्बाई अधिक है ? अपने उत्तर की पुष्टि के लिए कारण लिखिए ।

1

Two wires, one of copper and the other of manganin, have same resistance and equal thickness. Which wire is longer ? Justify your answer.

5. यहाँ आरेख में एक धनात्मक बिन्दु आवेश की क्षेत्र रेखाएँ दर्शाई गई हैं। Q तथा P बिन्दुओं के बीच किसी अल्प ऋणात्मक आवेश की स्थितिज ऊर्जाओं के अन्तर का चिह्न क्या होगा ? अपने उत्तर की पुष्टि के लिए कारण लिखिए।

1

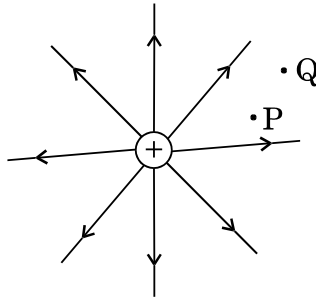

The figure shows the field lines of a positive point charge. What will be the sign of the potential energy difference of a small negative charge between the points Q and P ? Justify your answer.

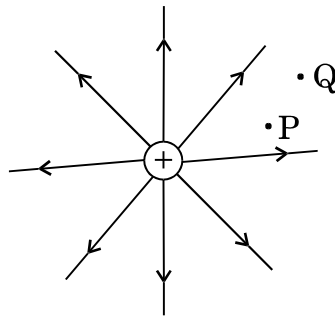

खण्ड ब

### SECTION B

6. R प्रतिरोध के I धारावाही एक चालक में 'शक्ति क्षय' पद को परिभाषित कीजिए। यह शक्ति क्षय किस रूप में प्रकट होता है ? दर्शाइए कि विद्युत् शक्ति स्टेशन से घरों तक विद्युत् धारा ले जाने वाले तारों (संचरण केबलों) में शक्ति क्षय को न्यूनतम करने के लिए यह आवश्यक है कि इन तारों में विद्युत् धारा की वोल्टता को अति उच्च रखा जाए।

2

Define the term 'power loss' in a conductor of resistance R carrying a current I. In what form does this power loss appear ? Show that to minimise the power loss in the transmission cables connecting the power stations to homes, it is necessary to have the connecting wires carrying current at enormous high values of voltage.



7. सोडियम के स्पेक्ट्रमी उत्सर्जन रेखा के प्रकाश की तरंगदैर्घ्य का मान 589 nm है। उस इलेक्ट्रॉन की गतिज ऊर्जा ज्ञात कीजिए जिसके लिए दे ब्रॉग्ली तरंगदैर्घ्य का मान भी इतना ही होगा।

2

The wavelength of light from the spectral emission line of sodium is 589 nm. Find the kinetic energy of the electron for which it would have the same de Broglie wavelength.

8. एक पर्दे को किसी वस्तु से 90 cm दूरी पर रखा गया है। एक उत्तल लेंस की दो भिन्न स्थितियों, जिनके बीच की दूरी 20 cm है, से पर्दे पर वस्तु के दो भिन्न प्रतिबिम्ब बनते हैं। लेंस की फोकस दूरी ज्ञात कीजिए।

2

A screen is placed 90 cm away from an object. The image of the object on the screen is formed by a convex lens at two different locations separated by 20 cm. Determine the focal length of the lens.

9. (a) निम्नांकित नाभिकीय अभिक्रिया में Z तथा A का मान निर्धारित कीजिए :

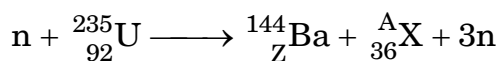

- (b) यदि प्रत्येक नाभिकीय अभिक्रिया में प्रोटॉन तथा न्यूट्रॉनों दोनों की संख्या संरक्षित रहती है, तो द्रव्यमान किस प्रकार ऊर्जा में रूपान्तरित होता है ? स्पष्ट कीजिए।

2

- (a) In the following nuclear reaction

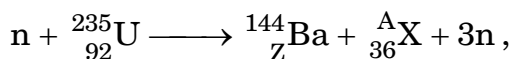

assign the values of Z and A.

- (b) If both the number of protons and the number of neutrons are conserved in each nuclear reaction, in what way is the mass converted into energy ? Explain.



10. संक्षेप में स्पष्ट कीजिए कि मोबाइल टेलीफोनी में संचार किस प्रकार होता है ।

2

अथवा

उपग्रह से संचार में, संचार की किस मूल प्रणाली (विधि) का उपयोग होता है ? इस विधि में किस प्रकार के तरंग संचरण का उपयोग होता है ?  $h_1$  तथा  $h_2$  ऊँचाइयों के दो एन्टेनाओं के बीच अधिकतम दृष्टिरेखीय दूरी  $d$  के लिए व्यंजक लिखिए ।

2

Explain briefly how communication takes place using mobile telephony.

OR

Which basic mode of communication is used in satellite communication ? Which type of wave propagation is used in this mode ? Write the expression for the maximum line of sight distance  $d$  between two antennas having heights  $h_1$  and  $h_2$ .

खण्ड स

### SECTION C

11. यहाँ दर्शाए गए परिपथ आरेख में  $10 \mu\text{F}$  के चार संधारित्रों को  $500 \text{ V}$  की सप्लाई से जोड़ा गया है । निर्धारित कीजिए :

3

- (a) नेटवर्क (जालक्रम) की तुल्य धारिता तथा  
(b) प्रत्येक संधारित्र पर आवेश ।

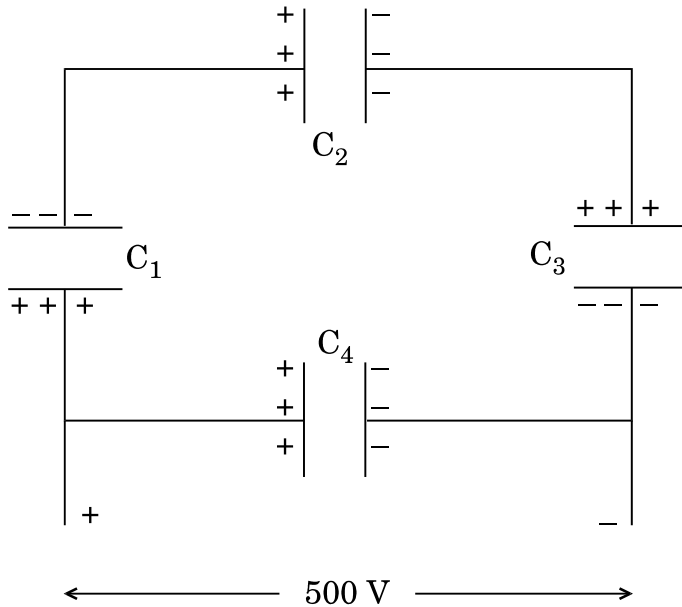

A network of four  $10 \mu\text{F}$  capacitors is connected to a  $500 \text{ V}$  supply as shown in the figure. Determine the

- equivalent capacitance of the network and
- charge on each capacitor.

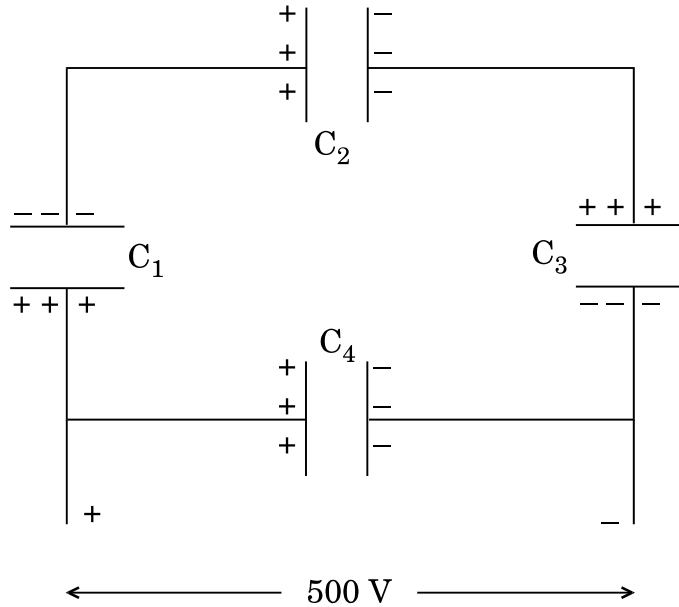

12.  $16 \Omega$  प्रतिरोध के एक तार को मोड़कर एक वर्ग बनाया गया है। इसकी एक भुजा के दो सिरों से  $9 \text{ V}$  विद्युत्-वाहक बल (ई.एम.एफ.) के एक स्रोत को चित्र अनुसार जोड़ दिया गया है। स्रोत से ली गई धारा का मान परिकलित कीजिए। इस वर्ग के सिरों C तथा D के बीच विभवान्तर ज्ञात कीजिए।

यदि इस तार को खींच कर दुगुनी लम्बाई व एकसमान मोटाई का एक तार बना दिया जाए और उसी सेल को उसी प्रकार बनाए गए वर्ग की एक भुजा के सिरों के बीच जोड़ दिया जाए, तो अब इसके किसी विकर्ण के दो सिरों के बीच विभवान्तर क्या होगा ?

3

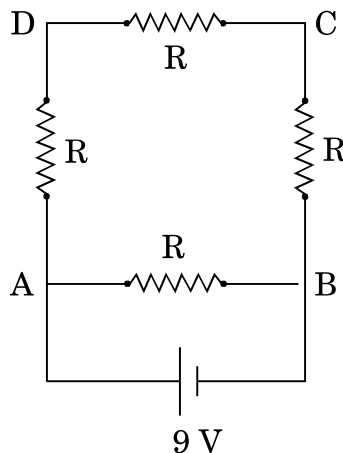



A  $16\ \Omega$  resistance wire is bent to form a square. A source of emf  $9\ \text{V}$  is connected across one of its sides as shown. Calculate the current drawn from the source. Find the potential difference between the ends C and D.

If now the wire is stretched uniformly to double the length and once again the same cell is connected in the same way, across one side of the square formed, what will now be the potential difference across one of its diagonals ?

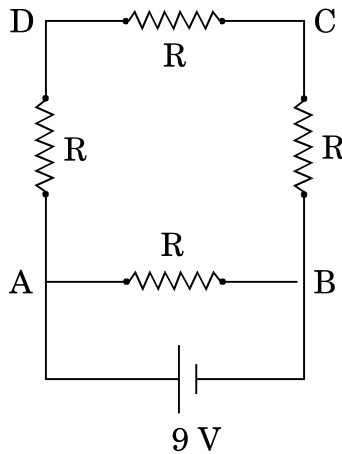

13. किसी कोष्ठ (चैम्बर) में  $6.5 \times 10^{-4}\ \text{T}$  का एकसमान चुम्बकीय क्षेत्र विद्यमान है। इस क्षेत्र में एक इलेक्ट्रॉन क्षेत्र से लम्बवत् दिशा में  $4.8 \times 10^6\ \text{m/s}$  की चाल से प्रवेश करता है। स्पष्ट कीजिए कि इस इलेक्ट्रॉन का पथ वृत्ताकार क्यों है। वृत्ताकार कक्षा में इसके घूर्णन की आवृत्ति ज्ञात कीजिए। क्या आवृत्ति इलेक्ट्रॉन की चाल पर निर्भर करती है ? स्पष्ट कीजिए।

3

A uniform magnetic field of  $6.5 \times 10^{-4}\ \text{T}$  is maintained in a chamber. An electron enters into the field with a speed of  $4.8 \times 10^6\ \text{m/s}$  normal to the field. Explain why the path of the electron is a circle. Determine its frequency of revolution in the circular orbit. Does the frequency depend on the speed of the electron ? Explain.

14. आवश्यक परिपथ आरेख बनाकर किसी सौर-सेल पर प्रकाश के आपतन से होने वाली उन तीन मूल प्रक्रियाओं का संक्षेप में वर्णन कीजिए जिनसे विद्युत्-वाहक बल (ई.एम.एफ.) उत्पन्न होता है। किसी सौर-सेल के लिए I – V अभिलाक्षणिक वक्र बनाइए।

सौर-सेलों के संविरचन (बनाने) के लिए पदार्थ का चयन करने के लिए आवश्यक दो महत्वपूर्ण मापदण्डों का उल्लेख कीजिए।

3

### अथवा

संक्षेप में वर्णन कीजिए कि प्रकाश उत्सर्जक डायोड (LED) को कैसे बनाया जाता है और इसकी कार्यविधि की व्याख्या कीजिए। परम्परागत तापदीप्त विद्युत् बल्बों की तुलना में एल.ई.डी. (LED) के तीन मुख्य लाभ लिखिए।

3

Describe briefly using the necessary circuit diagram, the three basic processes which take place to generate the emf in a solar cell when light falls on it. Draw the I – V characteristics of a solar cell.

Write two important criteria required for the selection of a material for solar cell fabrication.

### OR

Describe briefly how light emitting diode is fabricated and explain its working. Write three important advantages of LEDs over conventional incandescent lamps.

15. यंग के द्वि-झिरी प्रयोग के व्यतिकरण पैटर्न में प्रेक्षित लक्षणों तथा कलासंबद्ध प्रदीप्त एकल झिरी द्वारा उत्पन्न विवर्तन पैटर्न के तीन विभेदनकारी लक्षणों की तुलना कीजिए और उनकी व्याख्या कीजिए।

3

Compare and explain three distinguishing features observed in Young's double slit interference pattern with those seen for a coherently illuminated single slit producing diffraction pattern.



16. हाइड्रोजन परमाणु के बोर के अभिगृहीतों के उपयोग से,  $n$ वीं ( $n^{\text{th}}$ ) कक्षा में चक्कर लगाते हुए किसी इलेक्ट्रॉन की गतिज ऊर्जा (K.E.) के लिए व्यंजक व्युत्पन्न कीजिए और दर्शाइए कि
- $$\text{K.E.} = \frac{e^2}{8 \pi \epsilon_0 r_n}, \text{ जहाँ } r_n, n\text{वीं कक्षा की त्रिज्या है। } n\text{वीं कक्षा में स्थितिज ऊर्जा का कक्षीय त्रिज्या } r_n \text{ से क्या सम्बन्ध है ?}$$

3

Use Bohr's postulates of hydrogen atom to deduce the expression for the kinetic energy (K.E.) of the electron revolving in the  $n^{\text{th}}$  orbit and show that  $\text{K.E.} = \frac{e^2}{8 \pi \epsilon_0 r_n}$ , where  $r_n$  is the radius of the  $n^{\text{th}}$  orbit. How is the potential energy in the  $n^{\text{th}}$  orbit related to the orbital radius  $r_n$  ?

17. AND गेट (द्वार) तथा NOT गेट (द्वार) की सत्यमान सारणियों के उपयोग द्वारा दर्शाइए कि NAND गेट, AND गेट तथा NOT गेट का (इसी क्रम में) संयोजन है। इससे NAND गेट की सत्यमान सारणी बनाइए।

NAND गेटों (द्वारों) को 'सार्वत्रिक गेट' क्यों कहा जाता है ?

3

Using truth tables of AND gate and NOT gate show that NAND gate is an AND gate followed by a NOT gate. Hence write the truth table of NAND gate.

Why are NAND gates called 'Universal Gates' ?

18. आयाम माडुलित (AM) तरंग के उत्पन्न होने को स्पष्ट करने के लिए किसी सरल माडुलक का एक ब्लॉक आरेख बनाइए। क्या माडुलित संकेतों का इसी रूप में प्रसारण किया जा सकता है ? स्पष्ट कीजिए।

3

Draw a block diagram of a simple modulator to explain how the AM wave is produced. Can the modulated signal be transmitted as such ? Explain.

19. (a) किसी लेज़र द्वारा  $6 \times 10^{14}$  Hz आवृत्ति का एकवर्णी प्रकाश उत्पन्न होता है। उत्सर्जित शक्ति का मान  $2.0 \times 10^{-3}$  W है। इस स्रोत द्वारा औसतन कितने फ़ोटॉन प्रति सेकण्ड उत्सर्जित किए जाते हैं ?
- (b) यहाँ आरेख में, दो धातुओं X तथा Y के लिए आपतित विकिरणों की आवृत्ति ( $\nu$ ) के साथ निरोधी विभव  $V_0$  के विचलन (परिवर्तन) को दर्शाया गया है। यदि दोनों धातुओं पर आपतित विकिरणों की तरंगदैर्घ्य समान हो, तो किस धातु से, (दूसरी धातु की तुलना में) अधिक गतिज ऊर्जा के इलेक्ट्रॉनों का उत्सर्जन होगा ? स्पष्ट कीजिए।

3

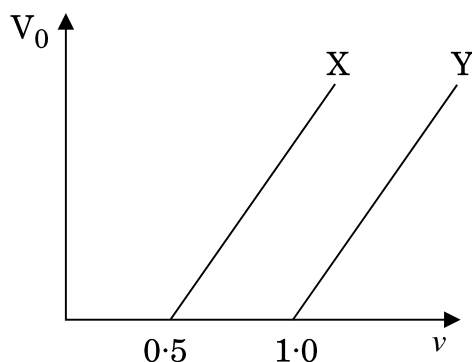

- (a) Monochromatic light of frequency  $6 \times 10^{14}$  Hz is produced by a laser. The power emitted is  $2.0 \times 10^{-3}$  W. How many photons per second on an average are emitted by the source ?
- (b) Figure shows variation of stopping potential ( $V_0$ ) vs. frequency ( $\nu$ ) of incident radiation for two metals X and Y. Which metal will emit electrons of larger kinetic energy for same wavelength of incident radiation ? Explain.

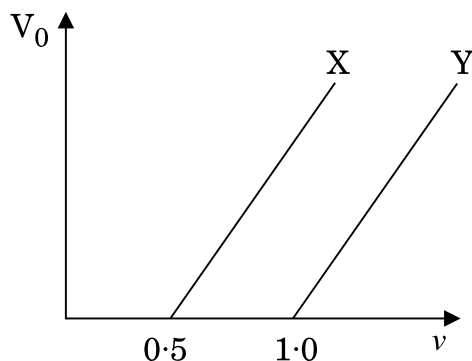

20. (a) मान लीजिए कि किसी तारे से  $6000 \text{ \AA}$  तरंगदैर्घ्य का प्रकाश आ रहा है। उस दूरदर्शी की विभेदन सीमा ज्ञात कीजिए जिसके अभिदृश्यक का व्यास  $250 \text{ cm}$  है।

(b) दो झिरियों (स्लिटों) के बीच की दूरी (पार्थक्य)  $1 \text{ mm}$  है तथा एक पर्दा इनसे  $1 \text{ m}$  दूर रखा गया है। प्रत्येक झिरी की चौड़ाई कितनी होनी चाहिए, ताकि एकल झिरी पैटर्न के केन्द्रीय उच्चिष्ठ के भीतर द्वि-झिरी पैटर्न के 10 उच्चिष्ठ प्राप्त हो सकें ?

3

(a) Assume that the light of wavelength  $6000 \text{ \AA}$  is coming from a star. Find the limit of resolution of a telescope whose objective has a diameter of  $250 \text{ cm}$ .

(b) Two slits are made  $1 \text{ mm}$  apart and the screen is placed  $1 \text{ m}$  away. What should be the width of each slit to obtain 10 maxima of the double slit pattern within the central maximum of the single slit pattern ?

21. धातु की एक छड़ की लम्बाई ' $l$ ' है। इसका एक सिरा धातु के किसी छल्ले (वलय) के केन्द्र पर हिंज किया गया है और दूसरा सिरा छल्ले की परिधि पर टिका है। छड़ को ' $\nu$ ' आवृत्ति से घुमाया जाता है। इसकी घूर्णन अक्ष छल्ले के समतल के लम्बवत् है तथा छल्ले के केन्द्र से होकर गुजरती है। इस घूर्णन अक्ष के समान्तर एक स्थिर तथा एकसमान चुम्बकीय क्षेत्र  $B$ , सर्वत्र विद्यमान है।

(a) केन्द्र तथा छल्ले के बीच प्रेरित विद्युत्-वाहक बल (ई.एम.एफ.) के लिए व्यंजक प्राप्त कीजिए।

(b) यदि दिया गया है कि छड़ का प्रतिरोध ' $R$ ' है, तो उत्पन्न शक्ति का मान क्या होगा ?

3

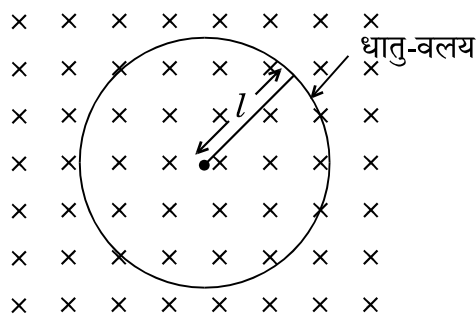

A metallic rod of length ' $l$ ' is rotated with a frequency ' $\nu$ ', with one end hinged at the centre and the other end at the circumference of a circular metallic ring, about an axis passing through the centre and perpendicular to the plane of the ring. A constant and uniform magnetic field  $B$  parallel to the axis is present everywhere.

- Obtain the expression for the emf induced between the centre and the ring.
- Given that the rod has resistance ' $R$ ', then how much power will be generated ?

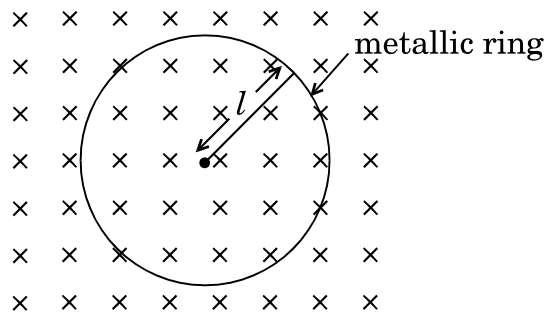

22. ऐम्पियर के व्यापकीकृत परिपथीय नियम के लिए व्यंजक लिखिए । उपयुक्त उदाहरण की सहायता से समय-आश्रित पद के महत्त्व को स्पष्ट कीजिए ।

3

Write the expression for the generalized Ampere's circuital law. Through a suitable example, explain the significance of time-dependent term.

## SECTION D

23. हरि अपने गाँव के पास स्थित किसी विद्यालय में 10वीं (दसवीं) कक्षा का छात्र है। उसके चाचाजी ने उसे डायनेमो-युक्त एक साइकिल उपहार में दी। वह यह जानकर रोमांचित हो गया कि अब वह रात में साइकिल चलाते हुए बल्ब जला कर सड़क पर पड़ी वस्तुओं को स्पष्ट देख सकता है। किन्तु, उसे यह ज्ञात नहीं था कि यह डायनेमो कैसे कार्य करता है। उसने यह प्रश्न अपने शिक्षक से पूछा। शिक्षक ने हरि के इस प्रश्न को डायनेमो की कार्यविधि को पूरी कक्षा को समझाने का एक अवसर माना।

निम्नलिखित प्रश्नों के उत्तर दीजिए :

4

- (a) डायनेमो के सिद्धान्त तथा उसकी कार्यविधि का उल्लेख कीजिए।
- (b) हरि तथा उसके विज्ञान शिक्षक द्वारा प्रदर्शित दो-दो मूल्यों का उल्लेख कीजिए।

Hari is a student of Class X in a school near his village. His uncle gifted him a bicycle with a dynamo fitted in it. He was thrilled to find that while cycling during night, he could light the bulb and see the objects on the road clearly. He, however, did not know how this device works. He asked this question to his teacher. The teacher considered it an opportunity and explained the working of a dynamo to the whole class.

Answer the following questions :

- (a) State the principle and working of a dynamo.
- (b) Write two values each displayed by Hari and his Science teacher.



## खण्ड य

### SECTION E

24. (a) ट्रांसफॉर्मर की कार्यविधि के सिद्धान्त को लिखिए । उपयुक्त आरेखों की सहायता से दर्शाइए कि किसी उच्चायी ट्रांसफॉर्मर में तार किस प्रकार लपेटे जाते हैं ।
- (b) किसी आदर्श ट्रांसफॉर्मर के लिए, उसकी प्राथमिक तथा द्वितीयक कुंडलियों में फेरों की संख्या के पदों में, (i) निर्गत तथा निवेशी वोल्टताओं और (ii) निर्गत तथा निवेशी धाराओं के बीच अनुपात के लिए व्यंजक व्युत्पन्न कीजिए ।
- (c) वास्तविक ट्रांसफॉर्मरों में ऊर्जा क्षय के मुख्य स्रोत क्या हैं तथा इनको कम कैसे किया जाता है ?

5

### अथवा

- (a) चल कुंडली धारामापी (गैल्वेनोमीटर) का एक नामांकित आरेख बनाइए । इसके कार्य करने का सिद्धान्त लिखिए । इसमें प्रयुक्त नर्म लोहे के क्रोड का क्या प्रकार्य है ?
- (b) (i) धारा सुग्राहिता तथा (ii) वोल्टता सुग्राहिता पदों की परिभाषा दीजिए ।
- (c) किसी गैल्वेनोमीटर को (i) वोल्टमीटर में तथा (ii) ऐमीटर में रूपान्तरित करने के लिए प्रयुक्त सिद्धान्त को स्पष्ट कीजिए ।
- (a) Write the principle of working of a transformer. Show, with the help of suitable diagrams, how the windings of a step-up transformer are done.
- (b) Assuming the transformer to be an ideal one, deduce the expression for the ratio of (i) output voltage to input voltage and (ii) output current to input current in terms of the number of turns in the primary and secondary coils.
- (c) What are the main sources of energy loss in actual transformers and how are these reduced ?

5

### OR

- (a) Draw a labelled diagram of a moving coil galvanometer. State its working principle. What is the function of a cylindrical soft iron core used in it ?
- (b) Define the terms (i) current sensitivity and (ii) voltage sensitivity.
- (c) Explain the underlying principle used in converting a galvanometer into a (i) voltmeter and (ii) ammeter.





25. (a) पूर्ण आंतरिक परावर्तन की परिघटना के संभव होने के लिए आवश्यक शर्तों (प्रतिबंधों) का उल्लेख कीजिए ।
- (b) एक किरण आरेख की सहायता से दर्शाइए कि क्राउन काँच के समकोणीय समद्विबाहु प्रिज़्म का उपयोग उल्टा प्रतिबिम्ब प्राप्त करने में किस प्रकार होता है ।
- (c) आवश्यक आरेख की सहायता से संक्षेप में स्पष्ट कीजिए कि पूर्ण आंतरिक परावर्तन की परिघटना का उपयोग प्रकाशिक तन्तुओं में कैसे होता है । एक उदाहरण की सहायता से समझाइए कि प्रकाशिक तन्तुओं का उपयोग प्रकाशिक संकेतों के प्रसारण (संचरण) में कैसे हो सकता है ।

5

### अथवा

- (a) यदि  $t = 0$  पर किसी तरंगाग्र का आकार दिया गया हो, तो यह दर्शाने के लिए उपयुक्त आरेख बनाइए कि  $t = t_1$  पर तरंगाग्र के आकार को हाइगेन्स की ज्यामितीय संरचना की सहायता से प्राप्त किया जा सकता है ।
- (b) किसी समतल तरंगाग्र के विरल माध्यम से सघन माध्यम में प्रवेश (संचरण) पर विचार करते हुए स्नैल के अपवर्तन नियम का सत्यापन कीजिए । दर्शाइए कि किसी तरंग के सघन माध्यम में अपवर्तन से उसकी तरंगदैर्घ्य तथा संचरण चाल घटती है, किन्तु उसकी आवृत्ति वही रहती है ।

5

- (a) State the essential conditions for the phenomenon of total internal reflection to take place.
- (b) Draw a ray diagram to show how a right isosceles prism made of crown glass can be used to obtain the inverted image.
- (c) Explain briefly with the help of a necessary diagram, how the phenomenon of total internal reflection is used in optical fibres. Illustrate giving an example how optical fibres can be employed for transmission of optical signals.

OR



- (a) Draw a suitable diagram to demonstrate that given the shape of a wavefront at  $t = 0$ , its shape at a later time  $t_1$  can be obtained using Huygens' geometrical construction.
- (b) Consider the propagation of a plane wavefront from a rarer to a denser medium and verify Snell's law of refraction. Show that when a wave gets refracted into a denser medium, the wavelength and speed of propagation decreases but the frequency remains the same.

26. (a) 'विद्युत् फ्लक्स' पद की परिभाषा दीजिए । इसका एस.आई. (S.I.) मात्रक लिखिए ।
- (b) किसी विद्युत्-क्षेत्र के अवयव दिए गए हैं :  $E_x = \alpha x$ ,  $E_y = 0$  तथा  $E_z = 0$ , जहाँ  $\alpha$  एक विमीय स्थिरांक है । यहाँ दर्शाए गए आरेख में घन (क्यूब) की भुजा 'a' है । इसके प्रत्येक तल से गुज़रने वाले फ्लक्स का तथा इसके भीतर प्रभावी आवेश का परिकलन कीजिए ।

5

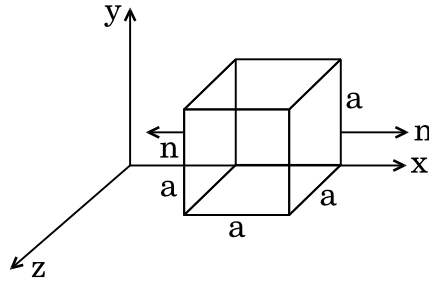

अथवा

- (a) समविभव पृष्ठ की परिभाषा दीजिए । समविभव पृष्ठ के किसी बिन्दु पर विद्युत्-क्षेत्र की दिशा उस बिन्दु पर पृष्ठ के अभिलम्बवत क्यों होती है ?
- (b) किसी विद्युत् द्विध्रुव के कारण समविभव पृष्ठों को दर्शाइए । आवेशों से दूरी के बढ़ने से उत्तरोत्तर समविभव पृष्ठ दूर-दूर क्यों हो जाते हैं ?
- (c) इस द्विध्रुव के लिए,  $x$  के साथ विभव  $V$  के परिवर्तन को दर्शाने के लिए एक ग्राफ़ (आलेख) बनाइए, जहाँ  $x$  ( $x \gg 2a$ ), दो आवेशों को जोड़ने वाली रेखा के अनुदिश, बिन्दु आवेश  $-q$  से दूरी है ।

5

- (a) Define the term 'electric flux'. Write its S.I. unit.
- (b) Given the components of an electric field as  $E_x = \alpha x$ ,  $E_y = 0$  and  $E_z = 0$ , where  $\alpha$  is a dimensional constant. Calculate the flux through each face of the cube of side 'a', as shown in the figure, and the effective charge inside the cube.

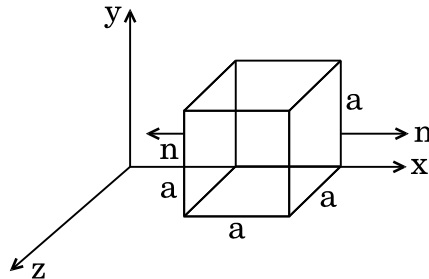

**OR**

- (a) Define equipotential surface. Why is the electric field at any point on the equipotential surface directed normal to the surface ?
- (b) Draw the equipotential surfaces for an electric dipole. Why does the separation between successive equipotential surfaces get wider as the distance from the charges increases ?
- (c) For this dipole, draw a plot showing the variation of potential  $V$  versus  $x$ , where  $x$  ( $x \gg 2a$ ), is the distance from the point charge  $-q$  along the line joining the two charges.



**MARKING SCHEME  
SET 55/1/G**

Q. No.	Expected Answer / Value Points	Marks	Total Marks
<b>Section A</b>			
Set1,Q1 Set2,Q5 Set3,Q2	Capacitive Reason: As current leads voltage ( by phase angle $\frac{\pi}{2}$ )	1/2 1/2	1
Set1,Q2 Set2,Q4 Set3,Q5	X – Transmitter Y - Channel	1/2 1/2	1
Set1,Q3 Set2,Q2 Set3,Q4	Focal length gets doubled. Power is halved.	1/2 1/2	1
Set1,Q4 Set2,Q3 Set3,Q1	Copper wire is longer. Reason: $\rho_c l_c = \rho_m l_m$ (as $\rho l = \text{constant}$ ) $\therefore l_c > l_m \therefore \rho_m > \rho_c$	1/2 1/2	1
Set1,Q5 Set2,Q1 Set3,Q3	Positive Reason: Negative charge moves from a point at a lower potential energy to one at a higher potential energy.	1/2 1/2	1
<b>Section B</b>			
Set1,Q6 Set2,Q7 Set3,Q10	<div style="border: 1px solid black; padding: 5px; margin-bottom: 10px;">                 Definition of Power loss <span style="float: right;">1/2</span>                  Form in which the power loss appear <span style="float: right;">1/2</span>                  Proof- (To minimise power loss in transmission cables                  Voltage should be high) <span style="float: right;">1</span> </div> <p>Electrical energy lost per second in the resistor, is Power loss  <math>\therefore</math> Power loss appears in the form of heat/ e. m. radiations.</p> <p>Consider a device ‘R’, to which power P is to be delivered via transmission cables having a resistance <math>R_c</math> , Let V be the voltage across ‘R’ , and I be the current through it, then</p> $P = V I \quad \therefore I = \frac{P}{V}$ <p>Power dissipated in the cable (<math>P_c</math>) = <math>I^2 R_c</math>  <math display="block">= \frac{P^2 R_c}{V^2}</math> <math display="block">\therefore P_c \propto \frac{1}{V^2}</math></p> <p><math>\therefore</math> Energy transmission, at high voltage, minimizes the power loss.</p>	1/2 1/2         1/2         1/2	2

	$\lambda = \frac{h}{p} = \frac{h}{\sqrt{2m E_k}}$ $\therefore \lambda^2 = \frac{h^2}{2m E_k}$ $E_k = \frac{(6.63 \times 10^{-34})^2}{2 \times 9.1 \times 10^{-31} \times (589 \times 10^{-9})^2} J$ $= 6.95 \times 10^{-25} J$ <p>Alternatively, <math>E_k = 4.35 \mu eV</math></p>	<p>1/2</p> <p>1/2</p> <p>1/2</p> <p>1/2</p>	2						
Set1,Q8 Set2,Q6 Set3,Q9	<table border="1"> <tbody> <tr> <td>Formula</td> <td>1/2</td> </tr> <tr> <td>Calculation &amp; result</td> <td>1 1/2</td> </tr> </tbody> </table> $\frac{1}{f} = \frac{1}{v} - \frac{1}{u}$ <p>(i) <math>\therefore \frac{1}{f} = \frac{1}{90-u} - \frac{1}{-u} = \frac{1}{90-u} + \frac{1}{u}</math> -----(1)</p> <p>(ii) <math>\frac{1}{f} = \frac{1}{70-u} - \frac{1}{-(u+20)} = \frac{1}{70-u} + \frac{1}{u+20}</math> -----(2)</p> <p>Solving eq<sup>n</sup> (1) and (2), u=35 cm</p> <p>Using lens formula f = 21.4 cm (Alternatively if a candidate calculates the focal length by using the formula <math>4fD = D^2 - d^2</math>, award full marks.)</p>	Formula	1/2	Calculation & result	1 1/2	<p>1/2</p> <p>1/2</p> <p>1/2</p> <p>1/2</p>	2		
Formula	1/2								
Calculation & result	1 1/2								
Set1,Q9 Set2,Q8 Set3,Q7	<table border="1"> <tbody> <tr> <td>(a) Value of Z</td> <td>1/2</td> </tr> <tr> <td>Value of A</td> <td>1/2</td> </tr> <tr> <td>(b) Explanation</td> <td>1</td> </tr> </tbody> </table> <p>(a) Z= 56 A=89</p> <p>(b) Difference in the total mass of the nuclei on the two sides of the reaction gets converted into energy or vice versa</p> <p><b><u>Alternatively.</u></b> The number is conserved but the B.E./ nucleon can be different for different nuclei.</p>	(a) Value of Z	1/2	Value of A	1/2	(b) Explanation	1	<p>1/2</p> <p>1/2</p> <p>1</p>	2
(a) Value of Z	1/2								
Value of A	1/2								
(b) Explanation	1								
Set1,Q10 Set2,Q9 Set3,Q6	<table border="1"> <tbody> <tr> <td>Explanation (4 steps)</td> <td>1/2 x 4 = 2</td> </tr> </tbody> </table> <p>Mobile telephony takes place in following ways:</p> <p>(i) Physical area is divided into smaller cell zones.</p> <p>(ii) Radio antenna in each cell receives and transmits radio signals, to and from, mobile phones.</p>	Explanation (4 steps)	1/2 x 4 = 2	<p>1/2</p> <p>1/2</p>					
Explanation (4 steps)	1/2 x 4 = 2								



	<b>OR</b>								
	<table border="1"> <tr> <td>Basic mode of communication</td> <td style="text-align: right;">1/2</td> </tr> <tr> <td>Type of mode</td> <td style="text-align: right;">1</td> </tr> <tr> <td>Expression for d</td> <td style="text-align: right;">1/2</td> </tr> </table>	Basic mode of communication	1/2	Type of mode	1	Expression for d	1/2		
Basic mode of communication	1/2								
Type of mode	1								
Expression for d	1/2								
	Line of sight / Broadcast Space wave $d = \sqrt{2Rh_1} + \sqrt{2Rh_2}$ , R is radius of earth (Also accept if the student writes $d \propto \sqrt{h}$ )	1/2 1 1/2	2						

Section C

Set1,Q11 Set2,Q20 Set3,Q15	<table border="1"> <tr> <td>(a) Equivalent capacitance</td> <td style="text-align: right;">1</td> </tr> <tr> <td>(b) Charge on each capacitor</td> <td style="text-align: right;">1+1</td> </tr> </table>	(a) Equivalent capacitance	1	(b) Charge on each capacitor	1+1		
(a) Equivalent capacitance	1						
(b) Charge on each capacitor	1+1						
	<p>(a) Equivalent capacitance (<math>C_n</math>) = <math>\frac{C}{3} + C</math>  <math>= \frac{4C}{3} = \frac{40}{3} \mu F</math></p> <p>(b) Charge on <math>C_4</math>, <math>q_4 = C_4 \times V = 10 \times 500 \mu C</math>  <math>= 5 \times 10^{-3} C = 5 mC</math></p> <p>Charge on <math>C_1, C_2, C_3</math> is same and is equal to <math>\frac{C}{3} \times V</math>  <math>= \frac{5}{3} \times 10^{-3} C</math>  <math>= 1.67 mC</math></p>	1/2 1/2 1/2 1/2 1/2 1/2	3				

Set1,Q12 Set2,Q21 Set3,Q16	<table border="1"> <tr> <td>Current drawn from the source</td> <td style="text-align: right;">1</td> </tr> <tr> <td>P.D across C and D</td> <td style="text-align: right;">1</td> </tr> <tr> <td>P.D across one of the diagonals</td> <td style="text-align: right;">1</td> </tr> </table>	Current drawn from the source	1	P.D across C and D	1	P.D across one of the diagonals	1		
Current drawn from the source	1								
P.D across C and D	1								
P.D across one of the diagonals	1								
	Net resistance of the circuit, $R_{eq} = 3 \Omega$ $\therefore$ Current, $I = \frac{V}{R_{eq}} = \frac{9}{3} = 3 A$ P.D across CD, $V_{CD} = I_{CD} \times R_{CD}$ $= \left( 3 \times \frac{1}{4} A \right) \times 4 \Omega = 3V$ When the wire is stretched to double its length, each resistance becomes four times, i.e. $16 \Omega$ each. P.D across one of the diagonal, $V_{AC}$ or $V_{BD} = \left( \frac{9}{12} \times \frac{1}{4} A \right) \times 32 \Omega = 6 V$	1/2 1/2 1/2 1/2 1/2 1/2	3						

Set1,Q13 Set2,Q22 Set3,Q17	<table border="1"> <tr> <td>Path of the electron</td> <td style="text-align: right;">1/2</td> </tr> <tr> <td>Determination of frequency of revolution</td> <td style="text-align: right;">1 1/2</td> </tr> <tr> <td>Dependence of frequency on speed</td> <td style="text-align: right;">1/2</td> </tr> </table>	Path of the electron	1/2	Determination of frequency of revolution	1 1/2	Dependence of frequency on speed	1/2		
Path of the electron	1/2								
Determination of frequency of revolution	1 1/2								
Dependence of frequency on speed	1/2								

**Alternatively,**

Because necessary centripetal force is provided by Lorentz magnetic force acting on the electron.

$$v = \frac{qB}{2\pi m}$$

$$= \frac{1.6 \times 10^{-19} \times 6.5 \times 10^{-4}}{2 \times 3.14 \times 9.1 \times 10^{-31}} \text{ Hz}$$

$$= 1.8 \times 10^7 \text{ Hz}$$

No

As  $v = \frac{qB}{2\pi m}$  i.e.  $v$  is independent of  $v$

1/2

1/2

1/2

1/2

1/2

3

Set1,Q14  
Set2,Q16  
Set3,Q18

Circuit Diagram	1/2
Three basic processes	1 1/2
I-V characteristics of solar cell	1/2
Important criteria	1/2

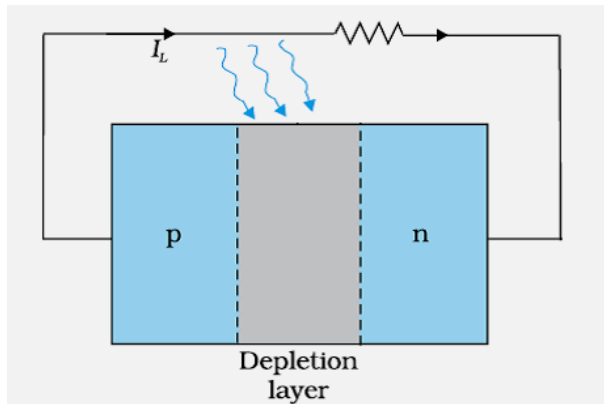

1/2

Three basic processes which take place to generate the emf in a solar cell are:

- (i) Generation of electron hole pairs due to the light incident close to the junction.
- (ii) Separation of electrons and holes due to the electric field of the depletion region.
- (iii) Collection of electrons and holes by n-side and p-side respectively.

1/2

1/2

1/2

I-V characteristics of solar cell

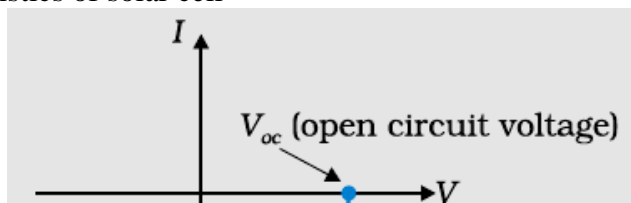

1/2



- Any one criteria of the following:
- (i) Small band gap (1.0 to 1.8 eV)
  - (ii) High optical absorption
  - (iii) Electrical conductivity
  - (iv) Availability of raw material
  - (v) Cost

1/2

**OR**

Fabrication of LED	1/2
Working	1
Three advantages of LEDs	1 1/2

3

An LED is fabricated from a semiconductor having a band gap  $\geq 1.8$  eV / LEDs of different colours are made from compound semiconductors.

1/2

**Working**

When LED is forward biased, the electrons move from  $n \rightarrow p$  and holes from  $p \rightarrow n$ ; thus concentration of minority charge carriers at the junction increases.

1/2

Excess minority charge carriers combine with majority charge carriers near the junction and release energy as photons.

1/2

**Advantages (Any three)**

- (i) Low operational voltage and less power
- (ii) Fast action and no warm-up time required.
- (iii) The bandwidth of emitted light is  $100 \text{ \AA}$  to  $500 \text{ \AA}$  or, in other words, it is nearly (but not exactly) monochromatic
- (iv) Long life and ruggedness
- (v) Fast on-off switching capability

1/2  $\times$  3  
= 1 1/2

3

Set1,Q15  
Set2,Q17  
Set3,Q11

Comparison and Explanation of three distinguishing features. 3

Interference	Diffraction
1) Equally spaced fringes	1) Fringes are not equally spaced
2) All maxima have equal brightness	2) Intensity of maxima keeps on decreasing
3) Formed by superposition of wavefronts from two coherent sources	3) Formed through superposition of wavelets from a single wavefront
4) There is a maxima at the angle $\lambda/a$	4) First minima occurs at an angle $\lambda/a$
5) Quite a large number of fringes are easily observable	5) It becomes difficult to distinguish maxima and

1  $\times$  3





Set1,Q16  
Set2,Q18  
Set3,Q12

Expression for K.E	2
Relation for P.E	1

For an electron (mass 'm' and charge 'e') revolving in n<sup>th</sup> stable circular orbit of radius 'r<sub>n</sub>', with velocity v<sub>n</sub>, in the hydrogen atom (z=1), we have

$$\frac{mv_n^2}{r_n} = \frac{1}{4\pi\epsilon_0} \frac{e^2}{r_n^2}$$

$$\therefore E_k = \frac{1}{2} mv_n^2 = \frac{e^2}{8\pi\epsilon_0 r_n}$$

$$\therefore E_p = \frac{1}{4\pi\epsilon_0} \frac{(+e) \times (-e)}{r_n}$$

$$= -\frac{e^2}{4\pi\epsilon_0 r_n}$$

1/2  
1/2  
1  
1/2  
1/2

3

Set1,Q17  
Set2,Q19  
Set3,Q13

Showing that AND gate followed by NOT gate is NAND gate	1
Truth table of NAND gate	1
Why is NAND gate called universal gate?	1

A	B	Output of AND gate (Input of NOT gate)	Output of NOT gate
0	0	0	1
0	1	0	1
1	0	0	1
1	1	1	0

Truth table of NAND Gate		
A	B	Y
0	0	1
0	1	1
1	0	1
1	1	0

NAND gate is called universal gate because all other basic gates like AND, OR, NOT gate, can be realised by using NAND gates only.

1  
1  
1

3

Set1,Q18  
Set2,Q11  
Set3,Q14

Block Diagram / Explanation of AM	1
Can AM wave be transmitted as such	1
Explanation	1

Block Diagram



	<p><b>Alternatively,</b> Explanation of Amplitude Modulation No / AM wave cannot be transmitted as such</p> <p><b>Explanation</b> The A.M. wave has to be fed to power amplifier to provide the necessary power. It is then fed to the antenna for transmission.</p>	1  1	3								
Set1,Q19 Set2,Q12 Set3,Q21	<table border="1" style="width: 100%;"> <tr> <td>(a) Formula</td> <td style="text-align: right;">1</td> </tr> <tr> <td>Calculation of number of photons per second</td> <td style="text-align: right;">1</td> </tr> <tr> <td>(b) Identification of Metal</td> <td style="text-align: right;">½</td> </tr> <tr> <td>Reason/explanation</td> <td style="text-align: right;">½</td> </tr> </table> <p>(a) <math>P = Nh\nu</math>  <math display="block">N = \frac{2 \times 10^{-3}}{(6.63 \times 10^{-34} \times 6.0 \times 10^{14})}</math> <math display="block">N = 5.0 \times 10^{15} \text{ photons per second}</math></p> <p>(b) Metal X  <math>(K.E = h\nu - \phi_o) / \because \phi_y &gt; \phi_x, \therefore (K.E)_x &gt; (K.E)_y</math></p>	(a) Formula	1	Calculation of number of photons per second	1	(b) Identification of Metal	½	Reason/explanation	½	1  ½ ½  ½ ½	3
(a) Formula	1										
Calculation of number of photons per second	1										
(b) Identification of Metal	½										
Reason/explanation	½										
Set1,Q20 Set2,Q13 Set3,Q22	<table border="1" style="width: 100%;"> <tr> <td>(a) Formula</td> <td style="text-align: right;">½</td> </tr> <tr> <td>Calculation and Result</td> <td style="text-align: right;">1</td> </tr> <tr> <td>(b) Formula</td> <td style="text-align: right;">½</td> </tr> <tr> <td>Calculation and Result</td> <td style="text-align: right;">1</td> </tr> </table> <p>(a) <math>\Delta\theta = \frac{1.22\lambda}{D}</math>  <math display="block">= \frac{1.22 \times 6 \times 10^{-7}}{2.5} \text{ radian}</math> <math display="block">\approx 2.9 \times 10^{-7} \text{ radian}</math></p> <p>(b) <math>10 \frac{\lambda D}{a} = 2 \frac{\lambda}{a}</math>  <math display="block">a = \frac{d}{5D} = \frac{10^{-3}}{5 \times 1} \text{ m}</math> <math display="block">= 2 \times 10^{-4} \text{ m} = 0.2 \text{ mm}</math></p>	(a) Formula	½	Calculation and Result	1	(b) Formula	½	Calculation and Result	1	½  ½ ½  ½  ½	3
(a) Formula	½										
Calculation and Result	1										
(b) Formula	½										
Calculation and Result	1										
Set1,Q21 Set2,Q14 Set3,Q19	<table border="1" style="width: 100%;"> <tr> <td>(a) Derivation for induced emf</td> <td style="text-align: right;">2</td> </tr> <tr> <td>(b) Expression for power</td> <td style="text-align: right;">1</td> </tr> </table> <p>(a) Emf induced <math>= \int_0^l Bwrdr</math>  <math display="block">= \frac{1}{2} B\omega l^2</math> <math display="block">\therefore \omega = 2\pi\nu</math></p>	(a) Derivation for induced emf	2	(b) Expression for power	1	½  ½					
(a) Derivation for induced emf	2										
(b) Expression for power	1										

Set1,Q22 Set2,Q15 Set3,Q20	<table border="1"> <tr> <td>Expression for generalized Ampere's Circuital law</td> <td>1</td> </tr> <tr> <td>Explanation of significance of time dependent term</td> <td>1</td> </tr> <tr> <td>Suitable Example</td> <td>1</td> </tr> </table>	Expression for generalized Ampere's Circuital law	1	Explanation of significance of time dependent term	1	Suitable Example	1		
Expression for generalized Ampere's Circuital law	1								
Explanation of significance of time dependent term	1								
Suitable Example	1								
	$\oint \vec{B} \cdot d\vec{l} = \mu_0 i_c + \mu_0 \epsilon_0 \frac{d\phi_E}{dt}$ $= \mu_0 \left( i_c + \epsilon_0 \frac{d\phi_E}{dt} \right) = \mu_0 (i_c + i_D)$	1							
	The time dependent term i.e. $\epsilon_0 \frac{d\phi_E}{dt}$ represents the displacement current.	1/2							
	It exists in the region in which the electric flux ( $\phi_0$ ) i.e. the electric field ( $\vec{E}$ ) changes with time.	1/2							
	Example- During charging or discharging of a capacitor, the current in the wire connecting the capacitor plates to the source is conduction current whereas in between the plates it is displacement current due to the change of electric field between the plates which makes the circuit complete.	1/2							
	The conduction current is always equal to the displacement current.	1/2							
			3						

### Section D

Set1,Q23 Set2,Q23 Set3,Q23	<table border="1"> <tr> <td>a) Principle of a dynamo</td> <td>1</td> </tr> <tr> <td>Working of a dynamo</td> <td>1</td> </tr> <tr> <td>b) Two values displayed by Hari</td> <td>1/2 + 1/2</td> </tr> <tr> <td>Two values displayed by Science teacher</td> <td>1/2 + 1/2</td> </tr> </table>	a) Principle of a dynamo	1	Working of a dynamo	1	b) Two values displayed by Hari	1/2 + 1/2	Two values displayed by Science teacher	1/2 + 1/2		
a) Principle of a dynamo	1										
Working of a dynamo	1										
b) Two values displayed by Hari	1/2 + 1/2										
Two values displayed by Science teacher	1/2 + 1/2										
	(a) Principle When magnetic flux through a coil changes , an emf is induced across its ends. Working : When the coil (Armature ) is rotated in a uniform magnetic field by some external means , the magnetic flux through it changes . So an emf is induced across the ends of the coil connected to an external circuit by means of slip rings and brushes.	1									
	(b) Two values displayed by Hari (Any two) Scientific temperament / curiosity / learning attitude / any other quality	1									
	Two values displayed by Science teacher (Any two) Responsive / caring and concerned / encouraging / any other quality	1/2 + 1/2									
		1/2 + 1/2									
			4								

### Section E

Set1,Q24 Set2,Q26 Set3,Q25	<table border="1"> <tr> <td>(a) Principle of working of a transformer</td> <td>1</td> </tr> <tr> <td>Labelled Diagram</td> <td>1</td> </tr> <tr> <td>(b) Deducing expression for the ratio of</td> <td></td> </tr> </table>	(a) Principle of working of a transformer	1	Labelled Diagram	1	(b) Deducing expression for the ratio of			
(a) Principle of working of a transformer	1								
Labelled Diagram	1								
(b) Deducing expression for the ratio of									

(a) Principle of working :

When the current through the primary coil changes , the magnetic flux linked with the secondary coil also changes . Hence an emf is induced across the ends of the secondary coil.

(If the student just writes , ‘mutual induction’ , award ½ mark)

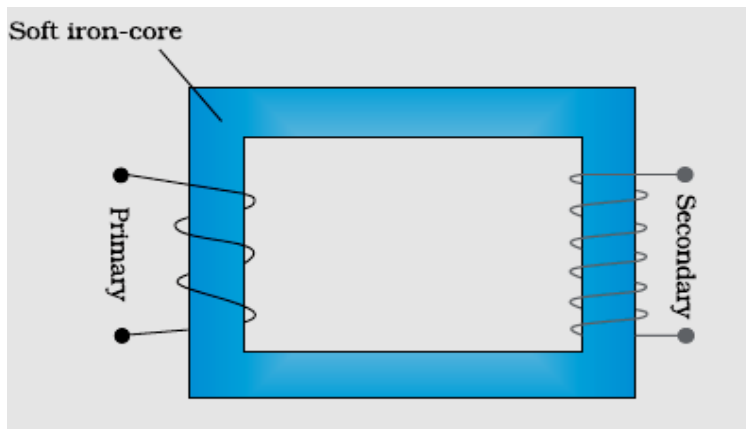

$$(b) (i) \frac{V_S}{V_P} = \frac{-N_S \frac{d\phi}{dt}}{(-N_P) \frac{d\phi}{dt}} = \frac{N_S}{N_P}$$

$$(ii) V_S I_S = V_P I_P$$

$$\therefore \frac{I_S}{I_P} = \frac{N_P}{N_S}$$

(c) Main source of energy losses ( any one)

Flux leakage / Joule’s loss / loss due to eddy currents / Hysteresis loss

How they are reduced (any one in the same order)

Winding the primary and secondary coils one over the other / using thick wires / having laminated core / using a magnetic material which has a low hysteresis loss

**OR**

(a) Labelled diagram of a moving coil galvanometer	1
Working Principle	½
Function of soft iron core	½
(b) Definition of	
(i) Current sensitivity	½
(ii) Voltage sensitivity	½
(c) Underlying Principle used in converting a galvanometer into	
(i) Voltmeter	1
(ii) Ammeter	1

1

1

½

½

½

½

½

½

5



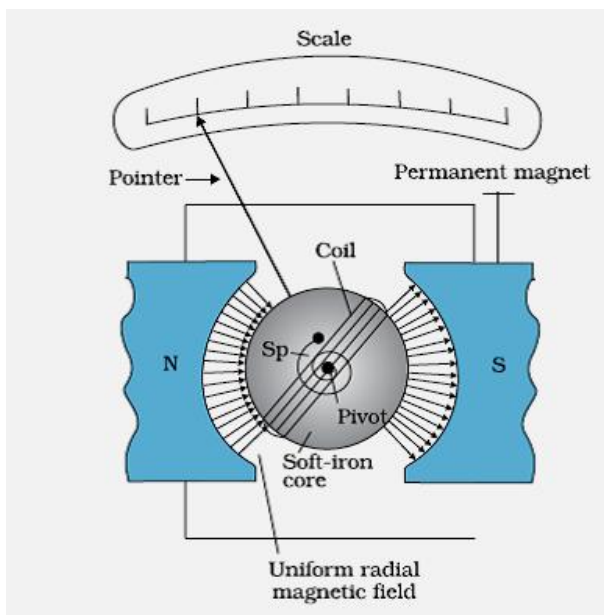

Principle : When a current carrying coil is kept in a magnetic field , it experiences a torque .

Cylindrical soft iron core makes the magnetic field radial.

(b)(i) Current sensitivity : It is defined as deflection produced per unit current flowing through the galvanometer.

(ii) Voltage sensitivity : It is defined as deflection produced per unit voltage applied across the galvanometer.

(c) (i) Conversion of galvanometer, into a voltmeter, is based on the fact that the voltmeter should have very high resistance so that very little (negligible) current flows through it.

(ii) Conversion of galvanometer, into an ammeter, is based on the fact that the ammeter should have very little (negligible) resistance so that it does not reduce the current in the circuit.

**Alternatively,**

A galvanometer can be converted into

(i) a voltmeter by connecting a suitable high resistance in series with its coil.

(ii) an ammeter by connecting a suitable shunt ( $I_{av}$ ) resistance parallel with its coil.

[Note: If the student just writes

$$(i) R = \left( \frac{V}{i_g} - G \right)$$

$$\text{and (ii) } S = \left( \frac{i_g}{I - i_g} \right) G$$

award ½ mark in each case]

1

½

½

½

½

1

1

5



(a) Essential conditions

- (1) The ray should pass from an optically denser medium into an optically rarer medium.
- (2) Angle of incidence should be greater than the critical angle for the given pair of media.

(b) Ray Diagram

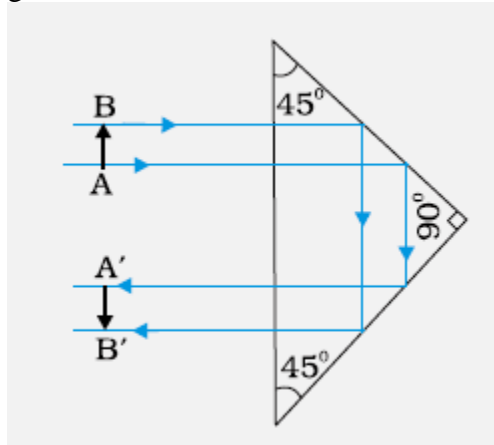

(c)

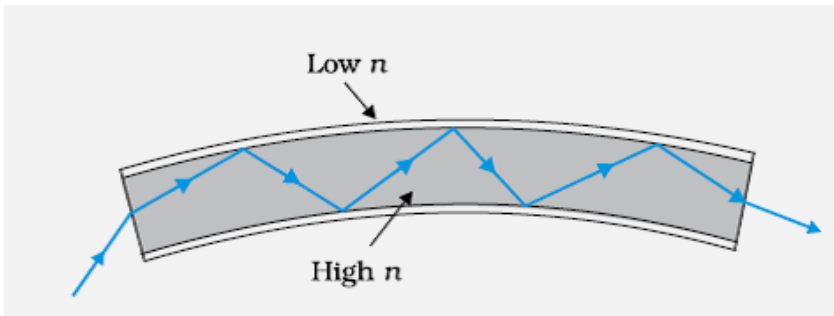

When ray of light enters into an optical fibre through one of its ends , it undergoes repeated total internal reflections along the length of the optical fibre as the angle of incidence at every point inside optical fibre is greater than the critical angle.

Example :

Optical fibres are used for transmitting and receiving optical signals to facilitate visual examination of internal organs of human body / for long distance communication through optical fibre cables. (any one)

OR

(a) Diagram demonstrating the location and shape of a wavefront using Huygen's principle	1
(b) Diagram	1
Verification of Snell's law	1 1/2

5

1  
1

1

1

1/2

1/2

(a)

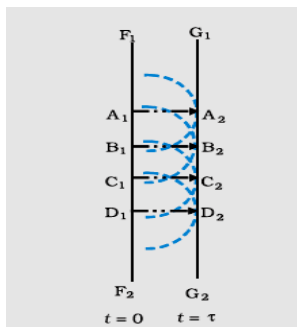

1

Alternatively,

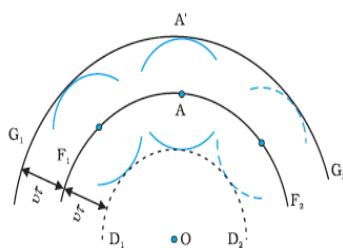

(Any one of the above diagram)

(b)

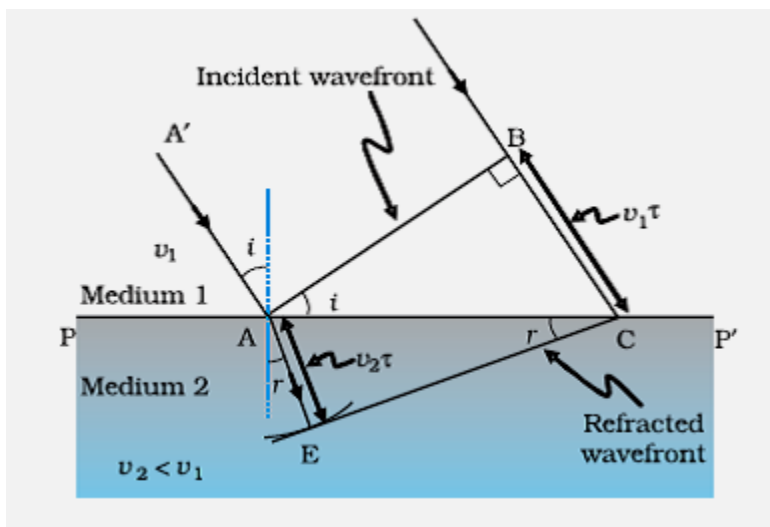

1

Let  $t$  be the time taken by the wavefront to travel the distance  $BC$  in rarer medium and  $AE$  in the denser medium

$$\begin{aligned} \therefore BC &= v_1 t \text{ and } AE = v_2 t \\ \therefore \frac{\sin i}{\sin r} &= \frac{BC}{AC} \times \frac{AC}{AE} = \frac{v_1 t}{v_2 t} \end{aligned}$$

1/2

	<p>Reason : If <math>\lambda_1</math> and <math>\lambda_2</math> denote the wavelengths of light in medium 1 and medium 2 , then if <math>BC = \lambda_1</math> , <math>AE = \lambda_2</math></p> $\frac{\lambda_1}{\lambda_2} = \frac{BC}{AE} = \frac{v_1}{v_2}$ <p style="text-align: center;">Or</p> $\frac{v_1}{\lambda_1} = \frac{v_2}{\lambda_2}$ <p>This equation implies that when a wave gets refracted into a denser medium , its wavelength and speed decrease but its frequency (<math>v/\lambda</math>)remains the same.</p>	<p>1/2</p> <p>1/2</p> <p>1/2</p>	5												
<p>Set1,Q26 Set2,Q25 Set3,Q24</p>	<table border="1" style="width: 100%; border-collapse: collapse;"> <tbody> <tr> <td style="padding: 5px;">(a) Definition of Electric flux</td> <td style="text-align: right; padding: 5px;">1</td> </tr> <tr> <td style="padding: 5px;">S.I unit</td> <td style="text-align: right; padding: 5px;">1/2</td> </tr> <tr> <td style="padding: 5px;">(b) Formula for Electric flux</td> <td style="text-align: right; padding: 5px;">1/2</td> </tr> <tr> <td style="padding: 5px;">Calculation and result for net flux</td> <td style="text-align: right; padding: 5px;">2</td> </tr> <tr> <td style="padding: 5px;">Formula and result for net charge</td> <td style="text-align: right; padding: 5px;">1/2 + 1/2</td> </tr> </tbody> </table> <p>(a) Definition : Total number of electric field lines passing perpendicularly through a surface is called electric flux. (Also accept: <math>\phi = \oint_s \vec{E} \cdot \vec{ds}</math>) S.I unit of electric flux is <math>Nm^2C^{-1}</math></p> <p>(b)From <math>\phi = \oint \vec{E} \cdot \vec{ds}</math> Net flux through the cube (<math>\Phi</math>) = Net flux through the two faces of the cube ( Perpendicular to X-axis + perpendicular to Y-axis + Perpendicular to Z-axis)</p> <p><math>\Phi = \phi_x + 0 + 0</math> (As <math>\vec{E} \cdot \vec{ds}</math> is (separately) zero for (<math>\vec{E} = \alpha x \hat{i}</math>) for the faces perpendicular to the y and the z-axis)</p> <p style="margin-left: 20px;"><math>= EdS \cos 180^\circ + EdS \cos 0^\circ</math></p> <p style="margin-left: 20px;"><math>= [\alpha(a)(-1) + \alpha(2a)]a^2</math></p> <p style="margin-left: 20px;"><b>(Alternatively:</b> <math>[\alpha(x)(-1) + \alpha(a+x)(+1)]a^2</math> <math>= \alpha a^3</math></p> <p>Net charge inside cube (<math>Q</math>)=<math>\Phi\epsilon_0</math> <math>= \alpha a^3 \epsilon_0</math></p> <p style="text-align: center;"><b>OR</b></p> <table border="1" style="width: 100%; border-collapse: collapse; margin-top: 10px;"> <tbody> <tr> <td style="padding: 5px;">(a) Definition of equipotential surface</td> <td style="text-align: right; padding: 5px;">1</td> </tr> </tbody> </table>	(a) Definition of Electric flux	1	S.I unit	1/2	(b) Formula for Electric flux	1/2	Calculation and result for net flux	2	Formula and result for net charge	1/2 + 1/2	(a) Definition of equipotential surface	1	<p>1</p> <p>1/2</p> <p>1/2</p> <p>1/2</p> <p>1/2</p> <p>1/2</p> <p>1/2</p> <p>1/2</p>	5
(a) Definition of Electric flux	1														
S.I unit	1/2														
(b) Formula for Electric flux	1/2														
Calculation and result for net flux	2														
Formula and result for net charge	1/2 + 1/2														
(a) Definition of equipotential surface	1														



(a) A surface having same potential at all points on it, is called an equipotential surface.

If the electric field were not normal to the equipotential surface, it will have a non-zero component along the surface. Hence, work

will be done in moving a unit test charge from one point to another point on the surface against this component of the field, which is not true.

**Alternatively:**

Component of  $\vec{E}$  along the equipotential surface

= - (rate of change of potential along the equipotential surface)

= zero

Hence  $\vec{E}$  has to be normal to the equipotential surface at all points.

(b)

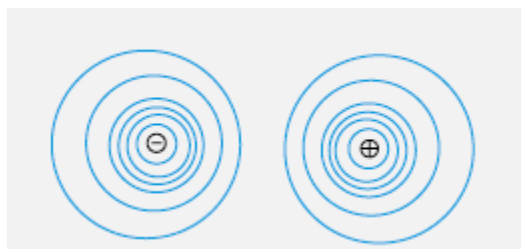

Reason :

Electric field decreases as the distance from the charges increases.

Also, electric field component, in any direction, equals the negative of rate of change of potential in that direction.

(c)

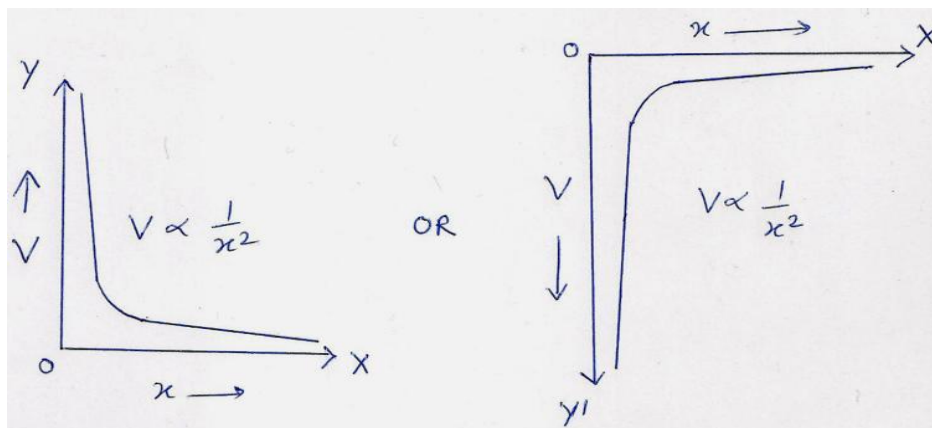

1

1

1

1

1

5

